



Whole House Water Filter **Rhino® Max Flow**

CITY WATER

Owner's Manual



Meet clean, healthy water. Your new Aquasana® whole house Rhino® system was expertly engineered to reduce contaminants, including 97% of chlorine, from the water throughout your entire home.

Enjoy the peace of mind that comes from knowing our award-winning water filter technology is working for you.

WH-1010 RHINO® MAX FLOW

TABLE OF CONTENTS

Box Contents & System Configurations	3
Installation Steps.....	4-12
Troubleshooting Guide	13
Maintenance.....	14
Filter Replacements	15-20
Performance & Certifications	21
Warranty	22
Water for Life® Program.....	23

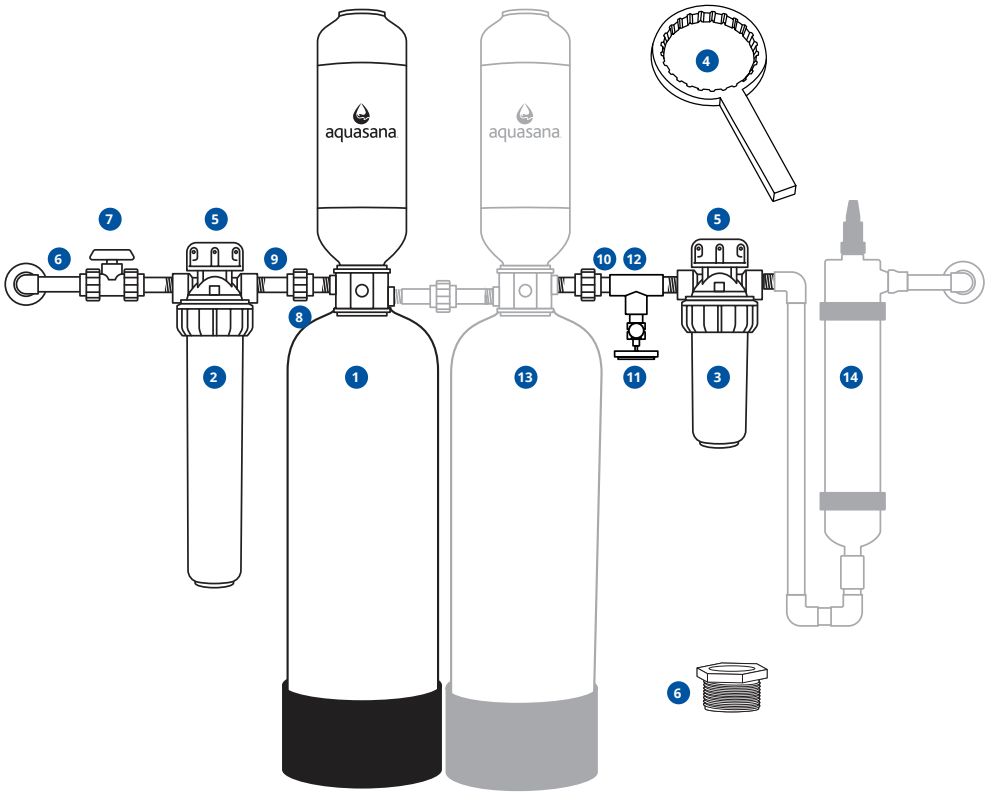

- | | |
|----------------------------------|--|
| 1 Rhino® Max Flow Tank | 8 Slip Unions (2) |
| 2 20" Pre-Filter | 9 2.5" TOE Nipples (5) |
| 3 10" Post-Filter | 10 3" Smooth Nipple |
| 4 Plastic Wrench | 11 Brass Drain Valve |
| 5 Filter Support Brackets (2) | 12 PVC Tee |
| 6 1" - 3/4" Reducer Bushings (2) | 13 Tall Salt-Free Water Conditioner (Optional) |
| 7 Shut-Off Valve | 14 Max Flow UV Filter (Optional) |

Box contents will be packaged in multiple boxes.

Before beginning installation, please ensure all parts listed are present. If any part is missing or damaged, do not attempt to install the system.

Please contact Customer Support for replacement parts at **866-662-6885**.

Tools recommended for installation:

- Drill
- Wrench
- Channel locks
- Pipe cutter
- NSF certified PVC primer and glue
- NSF certified plumber's tape
- Garden hose
- 5 gallon bucket

Optional components:

- Check valve
- Pro-Grade Bypass Kit
- Water hammer arrestor
- Copper wire & grounding clamps (if copper pipes are present)
- Pex tubing, crimp rings and cutter

[>> Click here to view the Rhino® Whole House installation video.](#)

Precautions

- **For all installations:** Due to the varieties of home design, not all configurations can be addressed in this guide. Anticipate the need for additional parts and pieces including but not limited to pex tubing, clamps, and mounting screws to install unit properly (available at a local home improvement store or through your plumbing contractor).
- **DO NOT** install this filter where the line pressure may exceed 100 psi. The operating pressure range for this filter is between 20psi – 100psi. In areas with high pressure, a pressure relief valve and a water hammer arrestor may be necessary.
- Install on cold water lines only (40° – 90°F).
- Installation of the filtration system must comply with existing state and local plumbing codes.
- Some local codes may require the use of a licensed plumber or certified installer when disrupting a potable water line.
- It is recommended your system be installed indoors and out of direct sunlight. Prolonged exposure to light can weaken plastic components, resulting in filter housing failure. If this is not possible and the system is outdoors or in a sunny area, the unit must be protected from both direct sunlight and freezing temperatures.
- Unit must be installed in an area where the main water line enters your home, before connecting to the water heater. **DO NOT** install after a water heater or on the hot water line.

Precautions (continued)

- **DO NOT** install the tank on its side. It must be installed upright to maximize contact with media bed.
- Pick an appropriate installation location where if the tank or any connection thereto should leak, the resulting flow of water will not cause damage to the surrounding area. Dimensions of systems vary—always allow an estimated minimum of 60" clearance for height of tank, and a minimum of 44" for floor space.
- Filtration tank must be flushed before running water from system into house.
- NSF certified plumber's tape (thread sealing tape) is the only sealer that can be used on threaded fittings. **DO NOT** use pipe dope or PVC primer/glue on threaded fittings. Exposure to these compounds will damage nipples causing leaks.
- Properly tighten all fittings to ensure a leak-free assembly.
- If installing on metallic plumbing, two grounding clamps and #4 copper wire are essential for safety.
- It is strongly recommended to install a check valve at the end of your system configuration and before the water heater to protect your filtration system from back flow.

① Select Location

Lay out system in appropriate configuration. Improper sequencing of equipment will affect performance, and could possibly damage your system.

1. Pick an appropriate installation location. Unit must be installed in an area where the main water line enters your home, and before it connects to the water heater. It is recommended to install after any outdoor hose bibs or irrigation lines to avoid using filtered water where not needed.

DO NOT install after the water heater or on the hot water line.

2. Choose the location for a shut-off valve to be able to isolate your system. If installing a check valve, it should be installed after your system but before the water heater. If installing the Pro-Grade Bypass Kit, choose the location at this time.

Pro-Grade Bypass Kit Installation:

IF YOUR SYSTEM does not include the Pro-Grade Bypass Kit, [continue to step 2](#).

NOTE: Due to the variety of home design and spaces, anticipate the need for additional items to install bypass loop properly. Additional items would be available at a local home improvement store or through your plumbing contractor. Not all configurations can be addressed in this guide.

1. Once you've selected an appropriate location for your whole home water filter system and main shut-off valve, lay out the bypass loop and ensure you have all the components and tools required.
 - The Pro-Grade Bypass Kit is specific to 1" PEX connections for easy installation.
 - Reference the [system configuration image](#) on page 9 when laying out bypass loop components to ensure correct order and location.
2. Pre-assemble all the parts before starting the installation. Straighten out your PEX tubing and plan for additional length that can be trimmed down before the final installation.
3. Mark your incoming water line where you would like to start your bypass loop. This should be before your main PVC shut-off valve. Prepare your existing pipes by cleaning the sections you plan to cut.
4. Once your bypass loop is prepared, continue to step 2 on next page before making the final connections.
5. Once the main system has been fully installed, cut down any PEX tubing to ensure you have the proper length and complete bypass loop connections.
6. Turn on main water line and check for leaks.

Bypass Kit Box Contents:

- 1 PEX 1" brass shut-off valves (2)
- 2 PEX 1" brass 90° elbows (2)
- 3 PEX 1" brass tees (2)
- 4 PEX 1" brass male adapters (2)

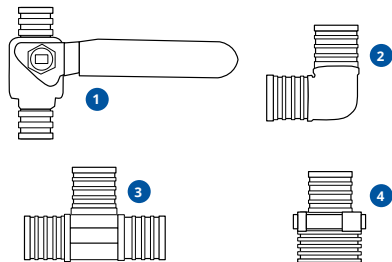

2 Prepare Rhino® Tank

1. Ensure the Rhino tank sits level. If it looks off-center or unlevel, reference the [troubleshooting section](#).
2. Pre-assemble all parts and dry-fit the entire system to ensure proper spacing and to confirm you have the necessary components for installation. Reference system configuration image on [page 3](#) to understand the system layout and connections.
3. Connect all smooth fitting connections using NSF certified primer and glue. Smooth connections will be on the nipples, unions, shut-off valve, and PVC tee. Once glue is applied, press and hold the connection tight for 10-15 seconds.
4. Carefully remove shipping caps from inlet and outlet ports without damaging valve threads.
5. Wrap threaded nipple ends 3 times with NSF certified plumber's tape. Insert the nipples and attached unions to the filtration tank's threaded inlet and outlet. Hand tighten and then tighten again with a pipe wrench (2-2.5 rotations) to seal the connections.

NOTE: DO NOT OVER-TIGHTEN. If space does not allow for a pipe wrench to grip the nipples, clamp to the glued union to make final rotations.

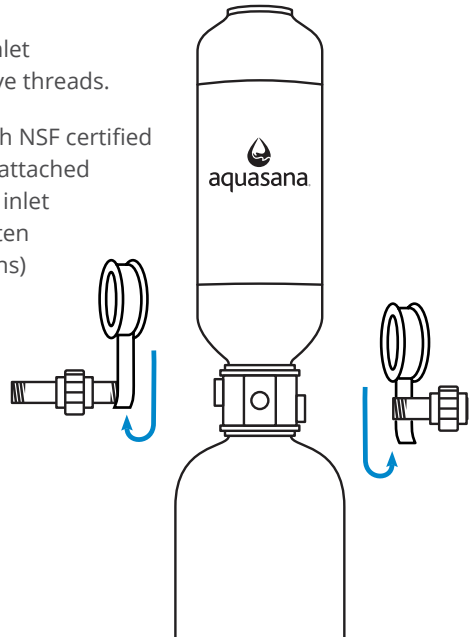

3 COPPER PIPES ONLY (proceed to Step 4 for all other pipes)

When installing on metallic plumbing, ensure you take the following precautions. Securely install two (2) grounding clamps and a #4 copper wire (not included) across the location where the system will be installed. Tightly clamp at both ends, as shown in the illustration.

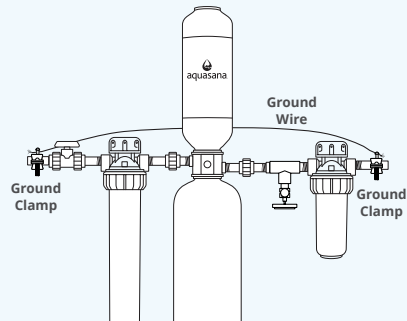

⚠ WARNING



ELECTRICAL SHOCK HAZARD

Prior to installation on metallic plumbing, securely install two grounding clamps and a #4 copper wire per installation instructions. Failure to follow these instructions can result in death or electric shock.

4 Install Shut-off Valve and Ensure Spacing

NOTE: You may need additional components to connect your system to the main water line where it enters and exits the filtration system. Ensure you have all components needed before proceeding to the next steps.

1. Turn off the main water source. Drain water from lines to relieve pressure by turning on a faucet at the lowest elevation inside your home.

NOTE: Installation could take 1–4 hours to complete. Plan accordingly as you will be without water throughout the home during this time.

2. Using a pipe cutter, cut into the main water supply line and catch any remaining water in the 5-gallon bucket. Each system includes a 1" PVC shut-off valve with the option of threaded or smooth connections, as well as reducer bushings to connect to a $\frac{3}{4}$ " main water line.
3. Loosely fit shut-off valve to calculate the proper spacing of components.
4. Measure distance for Pre- and Post-Filter, Rhino® tank, and optional add-ons (Salt-Free Water Conditioner and UV Filter) and mark pipe accordingly.

NOTE: DO NOT cut more pipe than necessary. You can cut more pipe later if needed. If you're installing a bypass loop, plan accordingly for the space required.

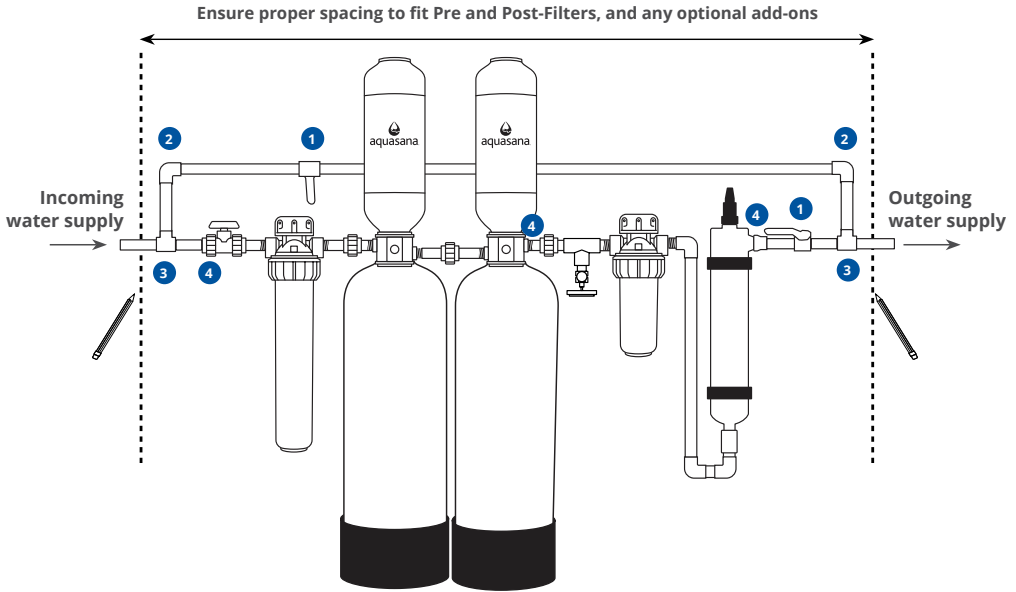

- 1 PEX 1" brass shut-off valves (2)
- 2 PEX 1" brass 90° elbows (2)
- 3 PEX 1" brass tees (2)
- 4 PEX 1" brass male adapters (2)

5 Cut Pipes

Cut pipe along the marked sections from step 4 and clean ends of pipe. Ensure there are no burrs, sharp edges, or deep scratches.

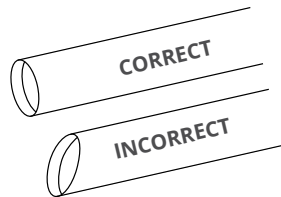

NOTE: Cut tubing as straight as possible with a utility knife, or an appropriate pipe cutter for copper, PVC, or PEX tubing.

6 Configure System

1. Fit Rhino® tank and additional optional add-ons into the system at this time.
2. Attach the shut-off valve to your incoming water line.
3. Connect the threaded nipple from the shut-off valve outlet to the 20" Pre-Filter housing inlet with NSF certified plumber's tape.

NOTE: If you upgraded to the Low Maintenance Pre-Filter, the following steps remain the same.

4. Attach the filter wall bracket to the Pre-Filter housing with included screws. Once this is complete, screw the support bracket to the wall.

NOTE: Additional materials may be needed to ensure Pre-Filter and Post-Filter brackets are supported and properly secured to wall.

5. Ensure all parts are flowing through the "IN" port in the correct direction of water flow.
6. Connect the threaded nipple from the Pre-Filter outlet to the union that is attached to the Rhino® tank inlet.
7. Connect drain valve into 1/2" threaded PVC tee with plumber's tape.
8. Connect the PVC tee to the union attached to the Rhino® tank outlet as well as the Post-Filter inlet with included nipples.
9. Attach the Post-Filter bracket and housing to the wall, similar to the Pre-Filter, and ensure all connections are tight.
10. If you have additional attachments, please reference those manuals before the final installation.
11. Once installation is complete, allow proper time for the glue to dry according to manufacturer instructions.

7 Flush Your System

NOTE: It's imperative that this system is flushed properly prior to system water entering your house. The granular carbon used in the filtration tank contains fines that must be flushed out prior to use.

1. Connect a garden hose to the integrated drain valve and ensure the drain valve is in the open position.
2. Ensure the garden hose outlet is directed towards a floor drain or outdoor area. If a bypass loop is installed, ensure each shut-off valve is in a closed position.
3. Slowly turn the water on from the initial shut-off valve and inspect for leaks. If any leaks are detected, refer to the troubleshooting section. If no leaks are detected, proceed with the flushing process.
4. Slowly turn the water on and allow discolored water to flow from the drain valve into a suitable drainage area. The first few gallons will appear black and cloudy due to carbon fines.

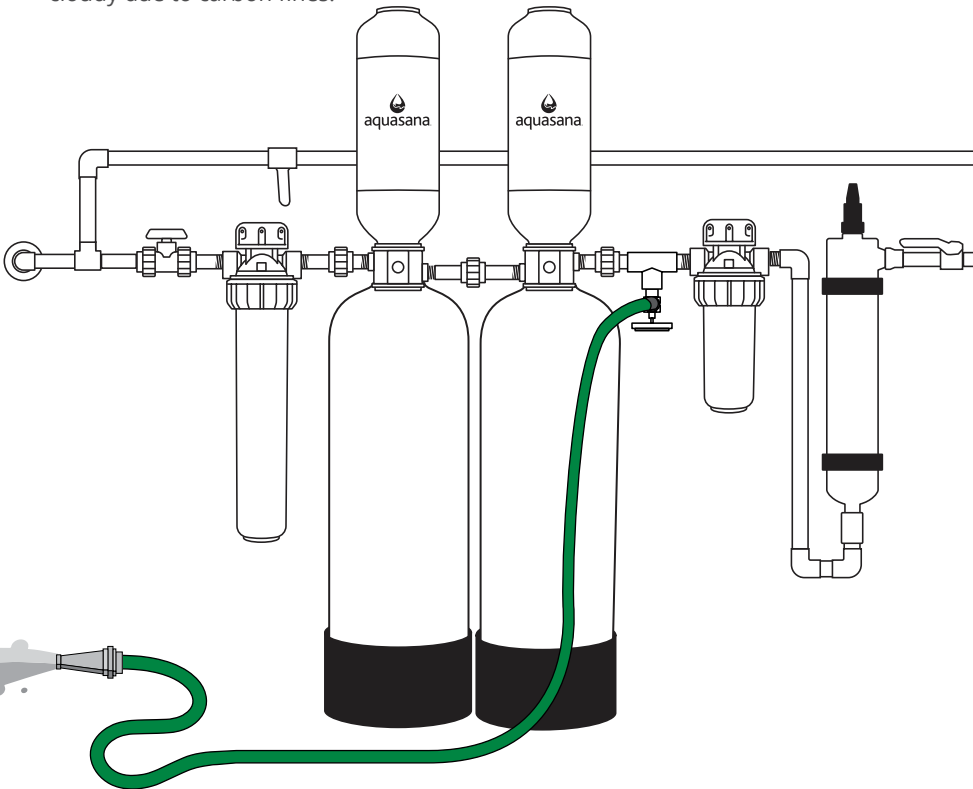

7 Flush Your System (continued)

- After the initial 15-minute flushing, begin a period of "surge flushing" by turning the water supply on for 30 seconds and then off for 30 seconds, repeating the cycle for 15 minutes or until the initial surge of water is completely clear and free from discoloration and cloudiness.

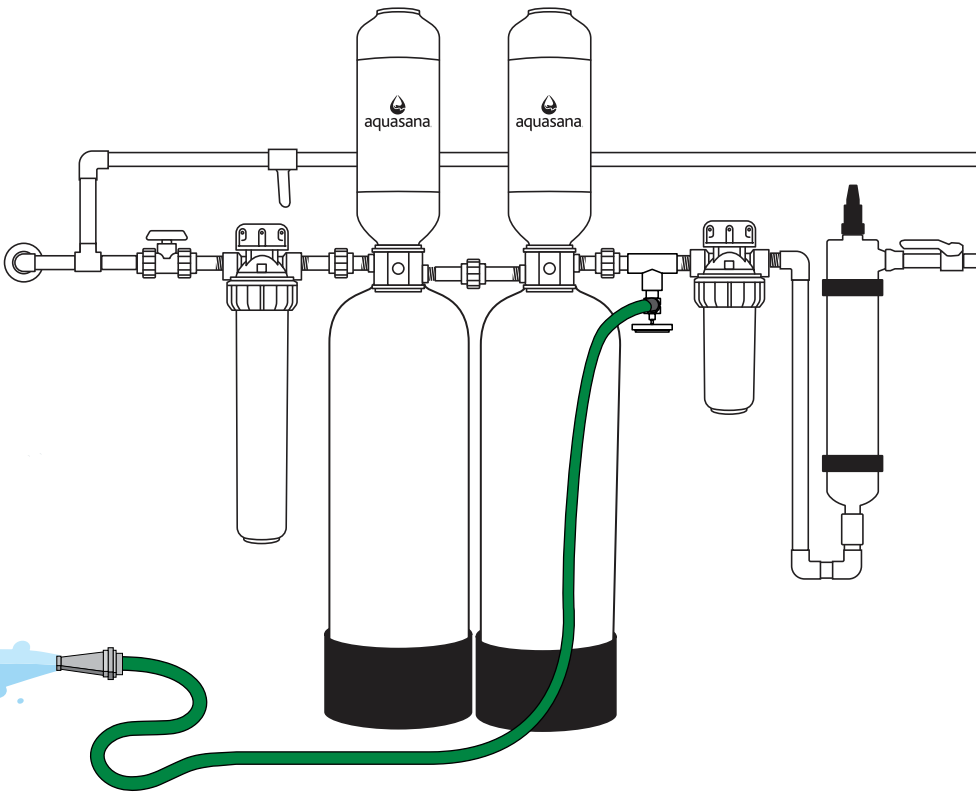

- Final installation is complete.** You may now close off the drain valve and enjoy filtered water throughout your home.

NOTE: Do not drink flushed water.

Issue	Resolution
Component is missing or arrived damaged.	Call customer service @ 1 (866) 662-6885 option 1, and then option 2, and then option 1. Please have order number, model number, and pictures of damaged packaging and/or damaged unit.
Tank leans to one side or is not level	Lift the tank straight up and tap down on the ground until the tank stands vertically. The bottom of the tank is round and the boot allows the tank to stand upright.
Water leak at seam of tank divider	Valve o-ring may not be placed properly or the top or bottom tank may have loosened during shipping. Use rubber strap wrench to tighten tanks. If leak continues, contact customer service with a pre-recorded video of leak.
Water leak from Aquasana fittings	<ul style="list-style-type: none"> • Ensure tight connection – do not overtighten as that could cause cracks and further leaking. • Close the shut-off valve before the leak. Unscrew the closest union and the threaded connection. Remove the previous sealing tape from the fitting and place more sealing tape and or tighten the connection properly. • Ensure all connections are properly tightened with a wrench – do not over-tighten! If the problem persists, contact customer service with pre-recorded video.
Water leak from pre/post filter housing	<ul style="list-style-type: none"> • Ensure tight connection – do not overtighten as that could cause cracks and further leaking. • Tighten the housing further with the included wrench. • If leak persists, close the shut-off valve before the leak. Remove housing and filter. Clean o-ring, inside the housing, and all threaded connections. Re-lubricate the o-ring and reassemble it with a new filter. • If a crack is visible and/or other methods do not stop the leak, contact customer service.
Reduced water pressure after installation	It is recommended that the sediment pre-filter be replaced every 2 months depending on the amount of sediment in your water supply. If the system has been working properly and the pressure is slowing, it may be time to change the sediment filter. Check the sediment filter and replace if necessary.
Water appears gray or cloudy	Let air flush from water lines. Cloudy water will dissipate over time (can take a week to a month) and is completely harmless.
Taste/odor of water did not improve	Ensure bypass loop is turned off and system shut-off valves are open.

Cleaning

- The exterior of your filtration system can be cleaned with warm, soapy water.
Do not use any abrasive solution.
- Rinse well with clean water.

NOTE: Never use chemical cleaning products on the system's exterior surface as they may damage the housing.

Pre/Post-Filter Replacements

Whole House 20" Pre-Filter Cartridge Replacement

Replace every 2 months. Replace sooner if there is a noticeable decrease in water flow through the filter system.

Whole House Low Maintenance Pre-Filter Cartridge Replacement

Replace every 6 months. Replace sooner if there is a noticeable decrease in water flow through the filter system.

Whole House 10" Post-Filter Cartridge Replacement

Replace every 6 months. Replace sooner if there is a noticeable decrease in water flow through the filter system.

Pre/Post-Housing Replacement

Replace every 5 years. To replace, call Customer Support.

How to change the Pre/Post-Filters:

1. Shut the filter system off at the shut-off valve **A**. Place a 5 gallon bucket under the system drain valve and open valve. This will relieve water pressure and drain excess water.

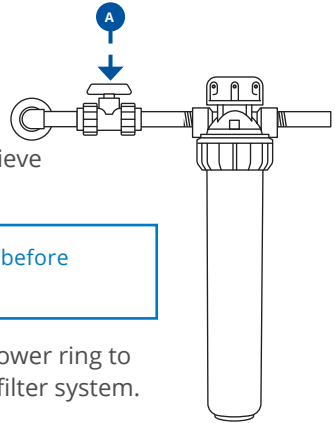

NOTE: You must relieve the pressure in your system before attempting to change any Pre-Filter or Post-Filter.

2. Remove the blue filter housing by turning the lower ring to the right, using the wrench supplied with your filter system. Remove the used filter.
3. If necessary, clean the inside of the blue filter housing with mild soapy water, rinse and dry.
4. Place new filter in the center of the blue filter housing.
5. Clean the housing o-ring and relubricate it with silicone grease. Set the o-ring into the proper groove and reattach the housing by screwing it back onto the top piece.

NOTE: DO NOT USE PETROLEUM JELLY as lubrication on the system or o-rings.

6. After reassembly, turn the system back on at the shut-off valve.
7. Run water, with the bucket still under the Pre-Filter. Check for leaks.

Specifications

This filter system is designed and tested for use with genuine Aquasana parts including replacement filters and all hardware. Use of parts from other manufacturers may result in loss of contaminant reduction performance, system damage, or failure. Use of parts from other manufacturers will also void your warranty. For replacement parts, please visit aquasana.com.

Model: WH-1010 System Replacements

20" Pre-Filter: EQ-303-20

10" Post-Filter: EQ-PFC.35

20" Low-Maintenance Pre-Filter: EQ-PFC.2045K

UV Lamp: AQ-UV-L420C

Quartz Sleeve: AQ-UV-Q420

Salt-Free Conditioner: WH-SFWC-TR

Rhino® Tank Replacement

1 Shut Off Water Supply

1. Turn off the main water source prior to tank replacement or turn off the shut-off valve.
2. Place a 5 gallon bucket under the system drain valve and open valve. This will relieve water pressure and drain excess water.

NOTE: You must relieve the pressure in your system before attempting to change the Rhino® tank.

⚠ WARNING



ELECTRICAL SHOCK HAZARD

If you have copper pipes - leave your grounding clamps installed. Do not disconnect at any time while changing the tank. Failure to follow this instruction can result in death or electric shock.

2 Remove Tank from System

1. Loosen the unions on both sides of the Rhino® tank. Slide the entire tank (pipe nipples and halves of unions included) away from the system.
2. Unscrew the pipe nipples from the tank.
3. Dispose of the old Rhino® tank properly.

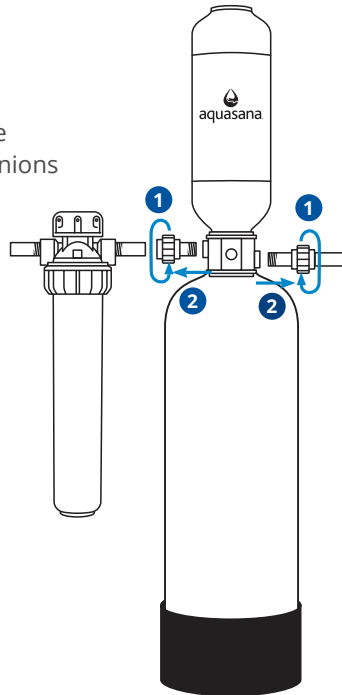

Rhino® Tank Replacement (continued)

3 Reconnect Fittings

1. Clean the threads on the pipe nipples and re-apply new NSF certified plumbers tape.
2. Connect pipe nipples to your new Rhino® tank.

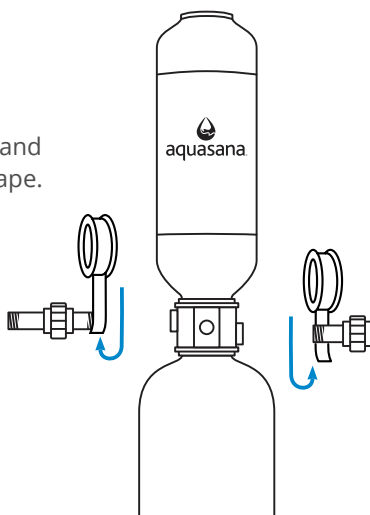

4 Plumb In New Rhino® Tank

Slide the new tank back into the system and re-attach the unions.

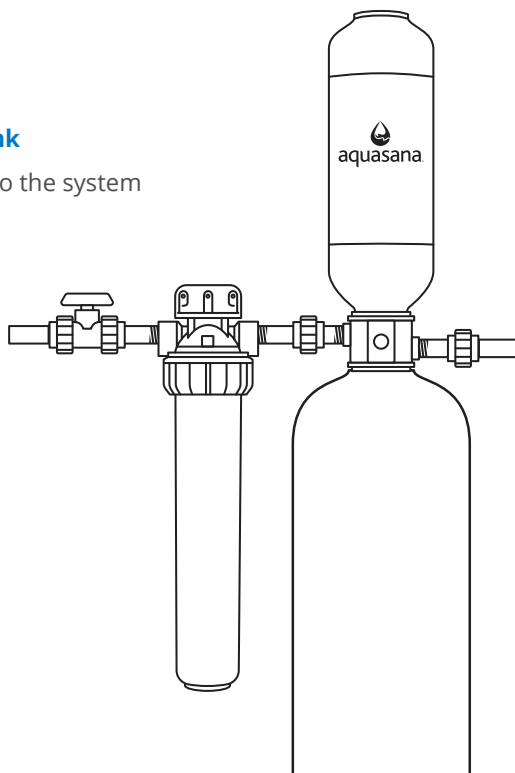

Rhino® Tank Replacement (continued)

NOTE: It's imperative that this system is flushed properly prior to system water entering your house. The granular carbon used in the filtration tank contains fines that must be flushed out prior to use.

5 Flushing New Rhino® Tank

1. Connect a garden hose to the integrated drain valve and ensure the drain valve is in the open position.
2. Ensure the garden hose outlet is directed towards a floor drain or outdoor area. If a bypass loop is installed, ensure each shut-off valve is in a closed position.
3. Slowly turn the water on from the initial shut-off valve and inspect for leaks. If any leaks are detected, refer to the [troubleshooting guide](#) on page 13. If no leaks are detected, proceed with the flushing process.
4. Slowly turn the water on and allow discolored water to flow from the drain valve into a suitable drainage area. The first few gallons will appear black and cloudy due to carbon fines.

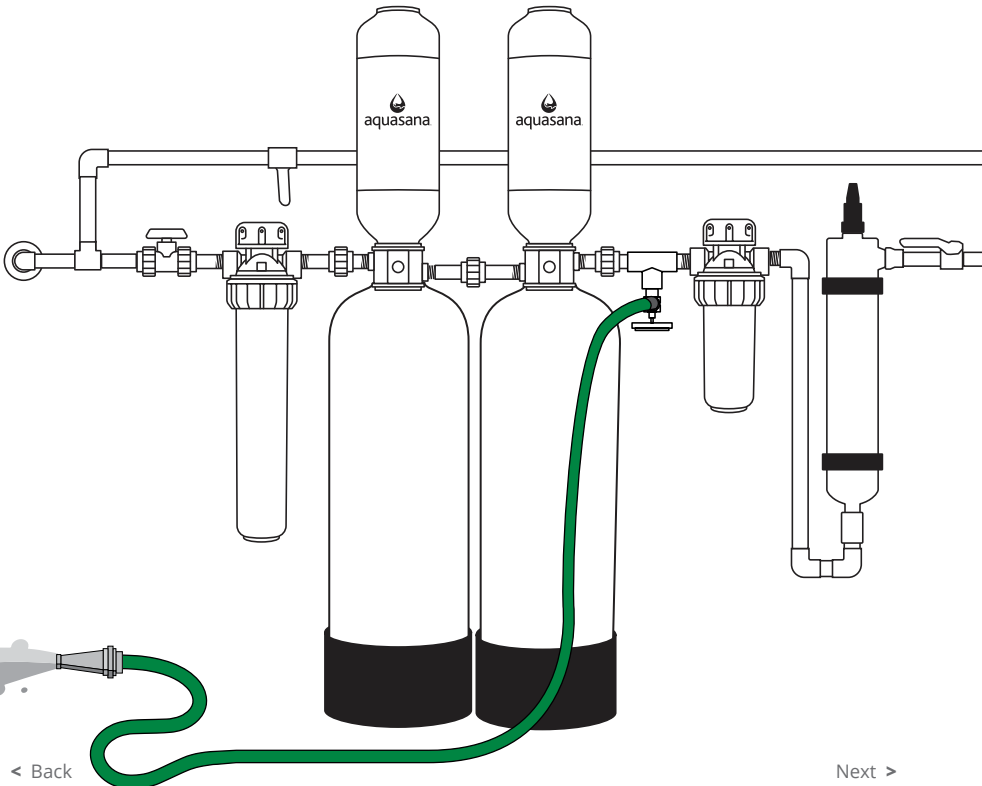

5 Flushing Process (continued)

5. After the initial 15-minute flushing, begin a period of "surge flushing" by turning the water supply on for 30 seconds and then off for 30 seconds, repeating the cycle for 15 minutes or until the initial surge of water is completely clear and free from discoloration and cloudiness.

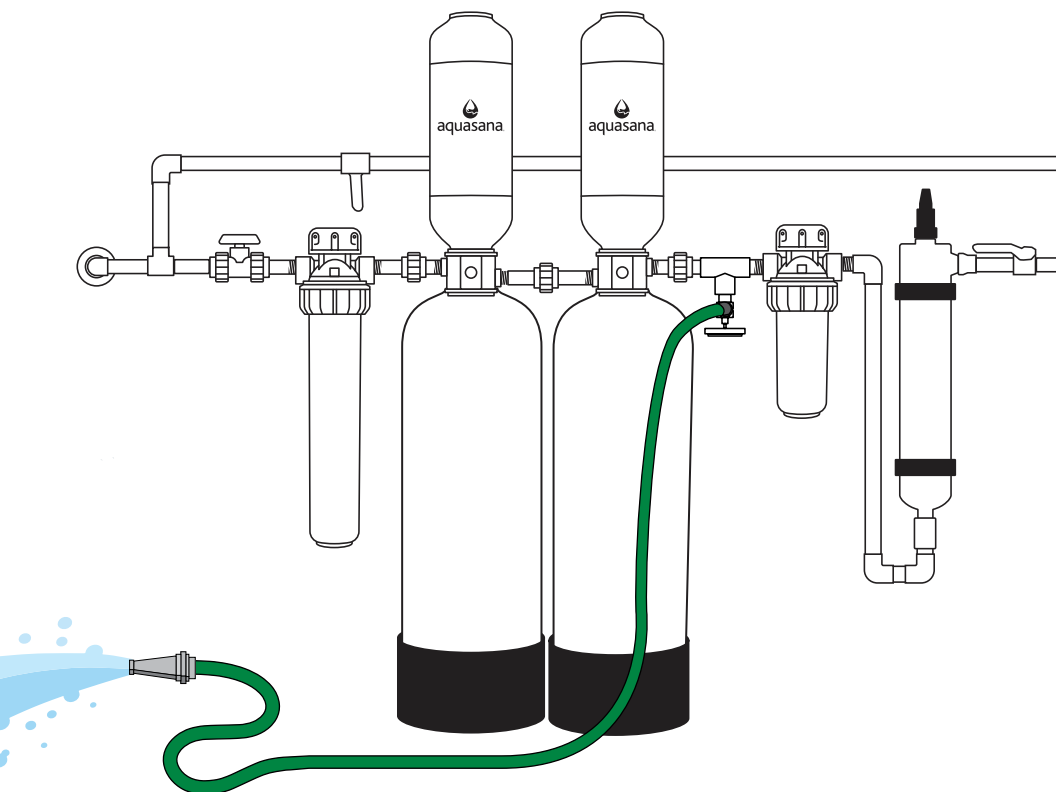

6. **Final installation is complete.** You may now close off the drain valve and enjoy filtered water throughout your home.

NOTE: Do not drink flushed water.

Model	Replacement	Rated Capacity
WH-1010	WH-1010R	1,000,000 gallons 3,785,411.78 liters
Operating Temp. Range	Operating Pressure Range	Rated Flow
40-90°F 4.44-32.2°C	20-100 psi 138-690 kPa	14.0 gpm 53.0 lpm
Manufactured by: Aquasana, Inc. 6310 Midway Road · Haltom City, Texas 76117 866-662-6885		



System independently tested to NSF/ANSI 42 for the claims specified on the Performance Data Sheet.

For the full list of contaminants filtered, go to the [Performance Data Sheet](#) on [Aquasana.com](#).



Rhino® tank tested and certified by WSA under NSF/ANSI/CAN 61 for Materials Safety Requirements Only and CSA B483.1 for Materials Safety and Structural Integrity Requirements. Not certified for contaminant reductions by WQA.



Rhino® Water Filter Limited Warranty

WHO IS COVERED

AQUASANA AND ITS SUPPLIERS, (herein collectively referred to as "Manufacturer") warrants to the owner of the home where the water filter is initially installed (hereinafter "Owner"). The warranty is restricted to the water filter used in a single-family residence in the United States of America and is void if moved from the original installation location.

WHAT IS COVERED

This Warranty covers defects in materials or workmanship during the limited warranty period of your AquaSana Rhino Whole House Filtration System including sub-components purchased with original system (may or may not include pre-filter, post-filter, and fittings), except as provided below. The water filter is warranted only when it is installed, operated and maintained in accordance with the instructions accompanying the water filter found on AquaSana.com. A water filter should be installed in such a manner that, if the tank or any connection thereto should leak, the resulting flow of water will not cause damage to the area in which it is installed. For detailed instructions read the manual accompanying the water filter and review drawings in the manual.

FOR HOW LONG

This warranty runs for months specified in chart below from the date of purchase by a consumer (hereinafter "Warranty Period"). No warranty coverage will be provided if the claimant is unable to provide proof of purchase. Water conditions and use rates may limit the functional lifespan of your filter. This Limited Warranty does not extend to the full estimated life span of the filter.

WHAT AQUASANA WILL DO

- If necessary, the Manufacturer will provide a replacement that fulfills the remaining estimated lifespan/capacity (see chart) of your original purchase and send it to you with installation instructions. If industry standards, product improvements or product obsolescence prohibit Manufacturer from furnishing an identical model replacement water filter under this warranty, the Owner will be furnished with a new water filter of comparable remaining capacity and functionality; however, the Owner will be charged for the additional value of the item(s) which Manufacturer has incorporated in the replacement water filter.
- Component Part – If any component part proves to Manufacturer's satisfaction to be defective in material or workmanship within the warranty period listed on the data plate label, the Manufacturer will furnish the Owner with a replacement for the defective part(s).
- Return of Defective Water Filter and Component Parts – Manufacturer reserves the right to examine the alleged defect in the water filter or component part(s), and it will be the Owner's obligation to return the water filter and/or component part(s) to the Manufacturer at the Manufacturer's request.
 - When returning a water filter, it must include all component parts.
 - When returning component part(s), they must be individually tagged and identified with the water filter's model number, date of purchase, and date of installation.

WHAT IS NOT COVERED

- This warranty does not cover filter cartridges and any systems that were not installed in compliance with the instructions or that have been abused or operated incorrectly.
- The Limited Warranty stated herein is in lieu of any and all warranties, express or implied (whether written or oral), including, but not limited to, the implied warranties of merchantability and fitness for a particular purpose.
- Manufacturer shall not be liable for any incidental, conse-

quential, special, or contingent damages or expenses, arising, directly or indirectly, from any defect in the water filter or the use of the water filter.

- Manufacturer shall not be liable for any water damage arising, directly or indirectly, from any defect in the water filter or component part(s) or from its use.
- Manufacturer shall not be liable for any damage or product failures caused by any of the following:
 - The water filter or any of its component parts have been subject to misuse, alteration, neglect or accident.
 - The water filter has not been installed in accordance with the applicable local plumbing and/or building code(s) and/or regulations or in their absence.
 - The water filter is not installed, operated and maintained in accordance with the printed Manufacturer's instructions, including if the water filter has any additional aftermarket equipment introduced into the sealed system not approved by the manufacturer.
 - The water filter is exposed to highly corrosive conditions.
 - The water filter is not continuously supplied with potable water.
 - The water filter is not operated within the factory calibrated temperature limits.
 - The water filter is removed from its original installation location.
 - The water filter is installed in direct sunlight or exposed to freezing temperatures.
 - The water filter or any of its component parts fail due to iron or sediment build-up.
 - Clogging due to purchaser's failure to replace the Pre-Filter cartridge.
 - Damage caused by fire, flood or acts of God.
 - Damage caused by over-pressurization in the water line.
- This warranty does not cover damage caused by the use of parts that are not genuine AquaSana parts. This includes, but is not limited to replacement filters, faucets, and/or diverter valves.
- Except when specifically prohibited by the applicable state law, the Owner, and not the Manufacturer, shall be liable for and shall pay for all charges for labor or other expenses incurred in the removal, repair or replacement of the water filter or any component part(s) claimed to be defective or any expense incurred to remedy any defect in the product. Such charges may include, but are not necessarily limited to:
 - All freight, shipping, handling and delivery costs of forwarding a new water filter or replacement part(s) to the owner.
 - All costs necessary or incidental in removing the defective water filter or component part(s) and installing a new water filter or component part(s).
 - Any material required to complete, and/or permits required for, installation of a new water filter or replacement part(s), and
 - All costs necessary or incidental in returning the water filter or component part(s) to a location designated by the manufacturer.

HOW TO GET SERVICE

To receive service under this Warranty, you must contact AquaSana (A. O. Smith Water Treatment (North America), Inc.) at 1-866-662-6885 or warranty@aquasana.com within the Warranty Period to describe the problem to a customer service representative who will verify that the product is under warranty and determine whether a part or the system will be replaced and whether you must send back the unit. You will be required to provide proof of purchase and proof of proper installation.

Rhino® System Warranty Coverage	
Model	Lifespan/Capacity
WH-1010	10 years / 1,000,000 gallons
Installation Kit (includes fittings purchased with original system)	12 months
Pre- and Post-Filter Housing Units	12 months

This warranty does not include the UV Filter. See full warranty information for the UV Filter in the original UV manual.



Protect your investment and save money with Water for Life®.

Our Water for Life® program helps you protect the investment you've made in your family's health with an extended limited warranty on your new filtration system, a 15% discount on replacement filters, and free shipping.



Extended Limited Warranty

Our performance promise to you – free replacement parts when needed.*



Discounted Replacements

The only way to lock in a 15% discount on replacement filters.



Free Shipping

Replacements shipped to you right when you need them – at no extra cost.



No Contract

Free to join and cancel anytime – no long-term commitment required.

CONTACT US TO LEARN MORE



866-662-6885



waterforlife@aquasana.com

**Exclusions apply. Limited Warranty details are available at aquasana.com. Benefits are for the term of Water for Life membership.*



LOVE IT?

Please let us know with a review on Aquasana or your retailer's website.



NEED HELP?

Give us a call at **866-662-6885** and tell us what's going on.

Aquasana, Inc.
6310 Midway Road
Haltom City, Texas 76117
866.662.6885 USA
877.332.7873 Canada
www.aquasana.com